

WAMAIR® Vacuum is a range of insertable polygonal filters designed for use under negative pressure (up to - 0.6 bar), especially for pneumatic conveying systems.

Its technical features and the compressed air cleaning system make it suitable for use in continuous mode.

WAMAIR® Vacuum ist eine Baureihe polygonaler Einschub-filter, die für Einsätze bei bis zu - 0,6 bar Unterdruck entwickelt wurde.

Als Haupteinsatzgebiet bieten sich daher pneumatische Fördersysteme an.

Die druckluftabgereinigten Filter geräte sind für Dauerbetrieb geeignet.

WAMAIR® Vacuum est une gamme de filtres polygonaux encastrables, développée pour des utilisations en dépression (jusqu'à - 0,6 bar), en particulier pour le transport pneumatique.

Ses caractéristiques techniques et le système de nettoyage à air comprimé, en font une machine adaptée à un usage en continu.

WAMAIR® Vacuum è una gamma di filtri poligonali inseribili sviluppati per impieghi in depressione (sino a - 0,6 bar), in particolare per il trasporto pneumatico.

Le sue caratteristiche tecniche ed il sistema di pulizia ad aria compressa, ne fanno una macchina adatta all'uso in continuo.



Comfortable pneumatically locked access cover for vertical type filter only

Komfortable Tür mit Pneumatikverschluss nur für vertikale Einhangfilter

Système pneumatique d'aide à l'ouverture du capot (seulement pour la version verticale)

Agevole sistema di apertura del portello con pistone pneumatico (solo per la versione verticale)

Compact overall dimensions and simplified maintenance thanks to air jet cleaning system integrated in access cover

Kompakte Einbaumaße und vereinfachte Wartung dank der in der Tür integrierten Abreinigungseinheit

Dimensions compactes et entretien simplifié grâce au système de nettoyage intégré dans le couvercle

Dimensioni compatte e manutenzione semplificata grazie al sistema di pulizia integrato nel coperchio

Seal frame in RAL 7001 powder-coated carbon steel (304 or 316 stainless steel on request)

Elementhalterungsplatte aus RAL 7001 pulverbeschichtetem Stahl (auf Wunsch aus Edelstahl 1.4301 bzw. 1.4401)

Plaque support des éléments filtrants en acier au carbone peint par poudrage époxy en RAL 7001 (inox 304, 316 sur demande)

Piastra porta elementi in Fe verniciata a polvere RAL 7001 (AISI 304, 316 su richiesta)



Highly efficient door fastener, 4 locking clamps in 304 st.st.

Hoch wirksame Türbefestigung, 4 Schnellverschlüsse aus Edelstahl 1.4301

Fixation parfaite du portillon, 4 crapauds de fermeture en inox 304.

Perfetto fissaggio portello, 4 ganci di chiusura (AISI 304)

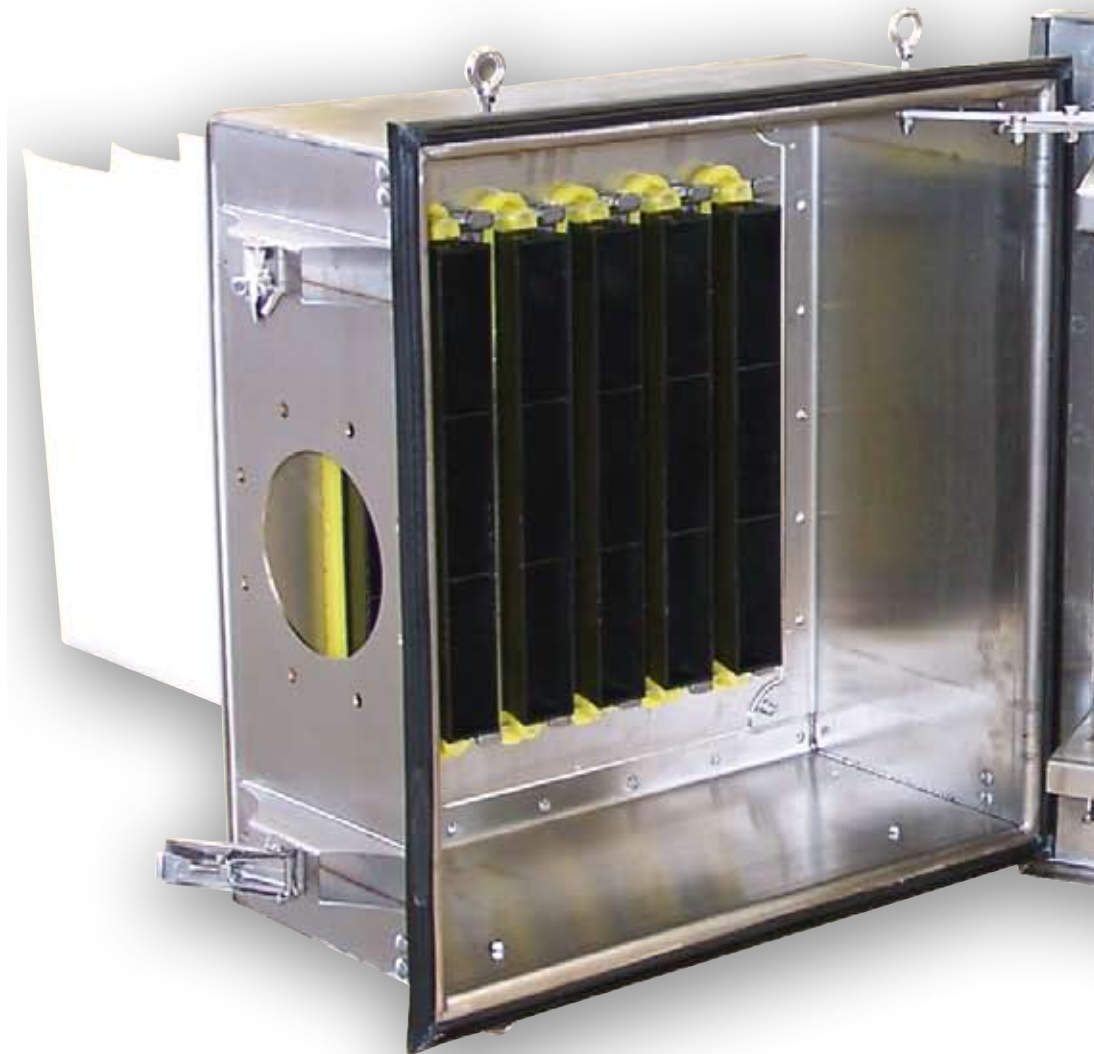

WAMAIR® Vacuum

equipment Bulk Solids Handling Equipment Bulk Solids Handling Equipment Bulk Solids Handling Equipment Bulk Solids Handling Equipment

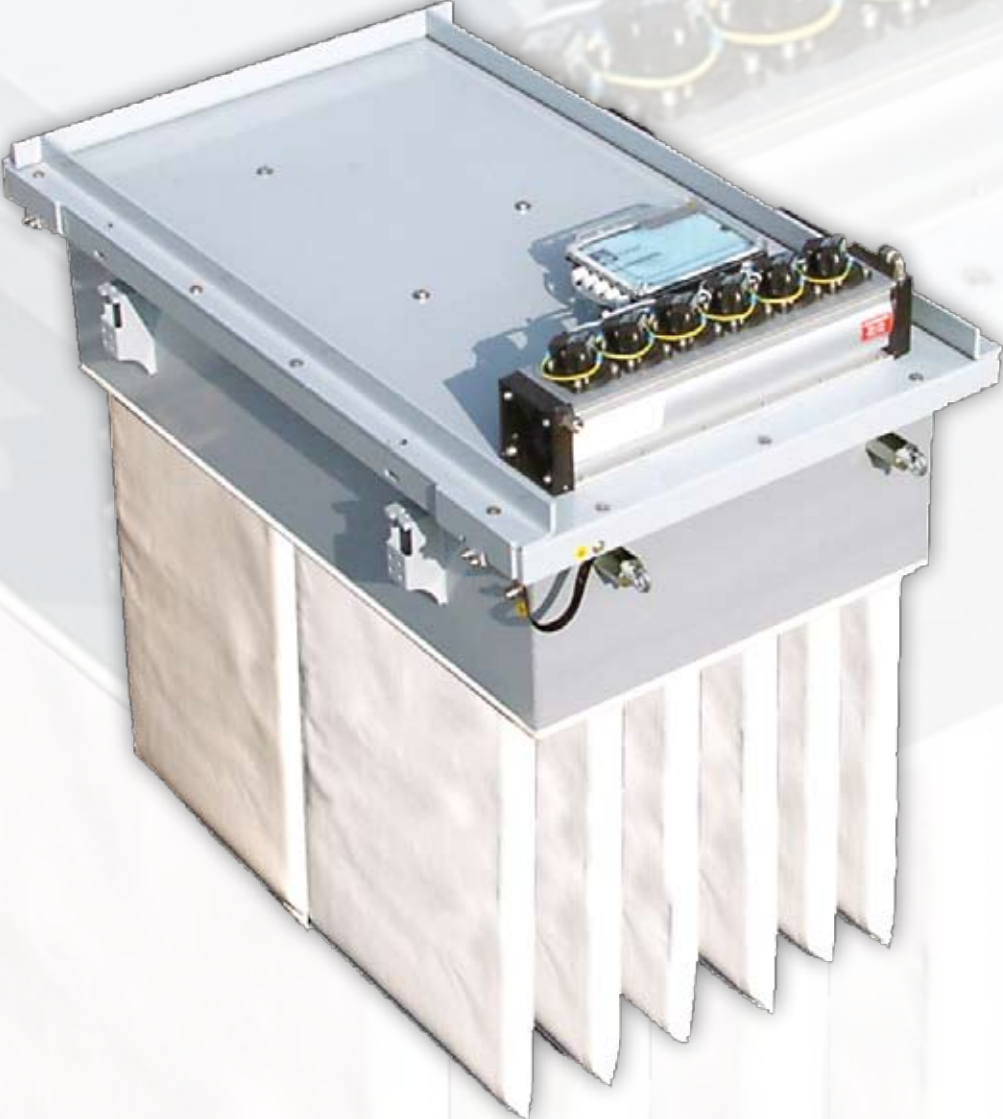

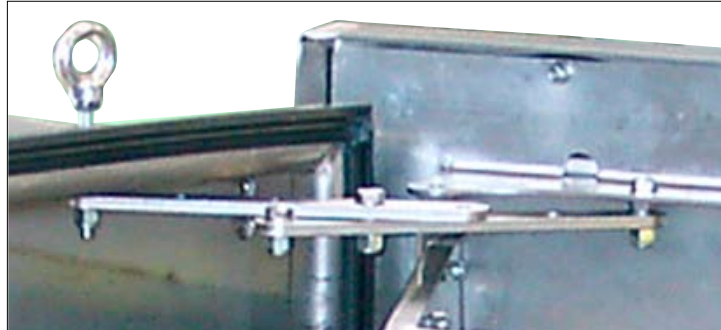

Self-locking access cover in open position for operator safety

Betriebssichere Türarretierung

Système de blocage pour la sécurité de l'opérateur

Sistema di blocco per la sicurezza dell'operatore



Body and access cover in RAL 7001 powder-coated carbon steel (304 or 316 stainless steel on request)

Gehäuse und Tür aus RAL 7001 pulverbeschichtetem Stahl (auf Wunsch aus Edelstahl 1.4301 bzw. 1.4401)

Corps / Couvercle en acier au carbone peint par poudrage époxy en RAL 7001 (inox 304, 316 sur demande)

Corpo / Coperchio in Fe verniciato a polvere RAL 7001 (AISI 304, 316 su richiesta)

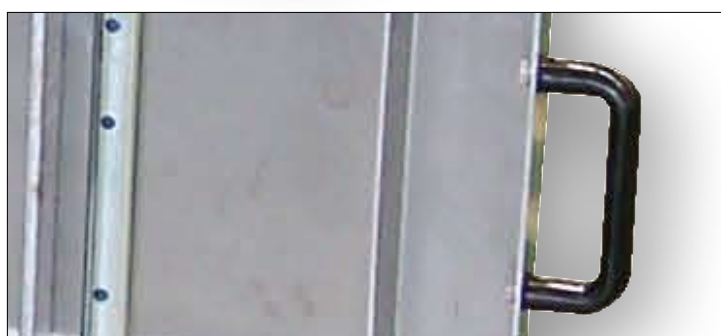

Easy door opening with one or two handles

Türöffnung mit ein oder zwei Griffen

Ouverture facile avec une ou deux poignées

Facile apertura con 1 o 2 maniglie

Horizontal Filters - *Horizontale Einschubfilter* - *Filtres horizontaux* - *Filtri orizzontali*

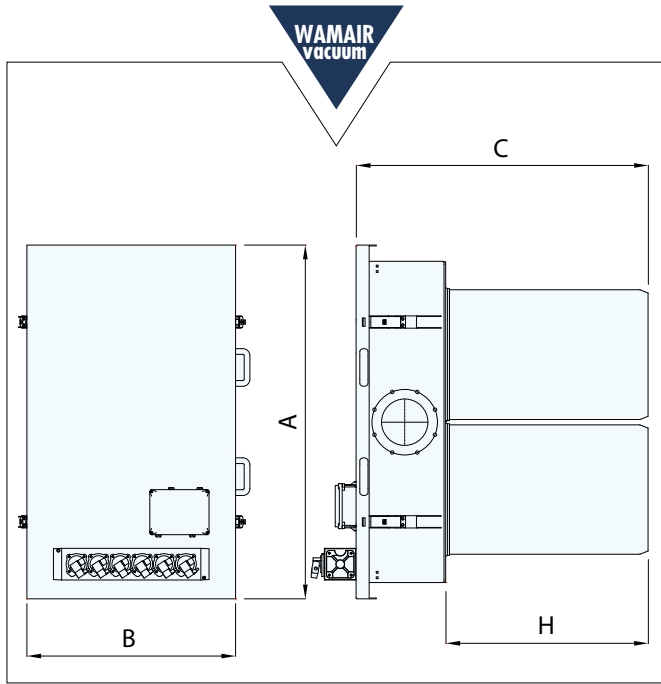

CODE	Filter Surface m ²	A	B	C	H	kg
FPN D T 1 03	03	800	765	828	500	91
FPN D T 2 05	05	800	765	1078	750	95
FPN D T 3 06	06	800	765	1328	1000	98
FPN D T 4 08	08	800	765	1578	1250	104
FPN D T 5 09	09	800	765	1828	1500	108
FPN D T 6 05	05	800	1040	828	500	121
FPN D T 7 07	07	800	1040	1078	750	127
FPN D T 8 09	09	800	1040	1328	1000	132
FPN D T 9 12	12	800	1040	1578	1250	141
FPN D T A 14	14	800	1040	1828	1500	147
FPN D T B 06	06	1296	765	828	500	136
FPN D T C 09	09	1296	765	1078	750	145
FPN D T D 12	12	1296	765	1328	1000	151
FPN D T E 15	15	1296	765	1578	1250	164
FPN D T F 18	18	1296	765	1828	1500	172

Dimensions in mm

Vertical Filters - *Vertikale Einhangfilter* - *Filtres verticaux* - *Filtri verticali*

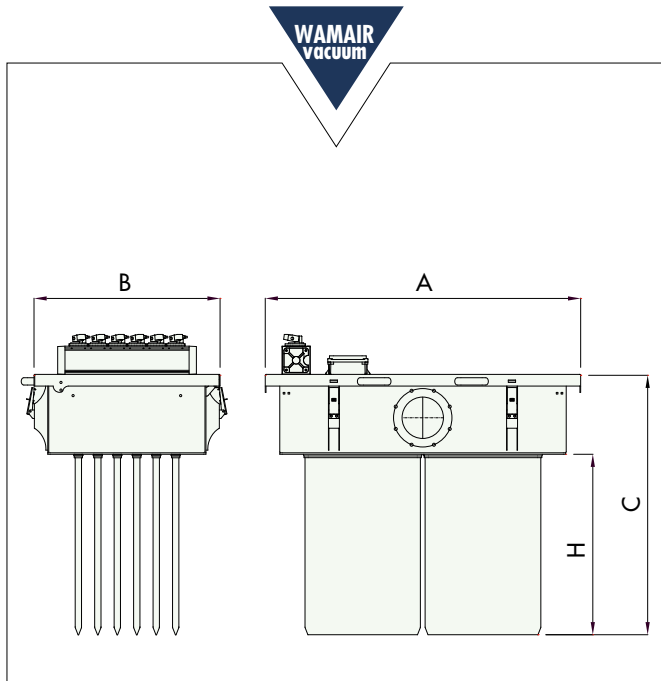

CODE	Filter Surface m ²	A	B	C	H	kg
FPN G T 1 03	03	800	765	828	500	91
FPN G T 2 05	05	800	765	1078	750	95
FPN G T 3 06	06	800	765	1328	1000	98
FPN G T 4 08	08	800	765	1578	1250	104
FPN G T 5 09	09	800	765	1828	1500	108
FPN G T 6 05	05	800	1040	828	500	121
FPN G T 7 07	07	800	1040	1078	750	127
FPN G T 8 09	09	800	1040	1328	1000	132
FPN G T 9 12	12	800	1040	1578	1250	141
FPN G T A 14	14	800	1040	1828	1500	147
FPN G T B 06	06	1296	765	828	500	136
FPN G T C 09	09	1296	765	1078	750	145
FPN G T D 12	12	1296	765	1328	1000	151
FPN G T E 15	15	1296	765	1578	1250	164
FPN G T F 18	18	1296	765	1828	1500	172

Dimensions in mm

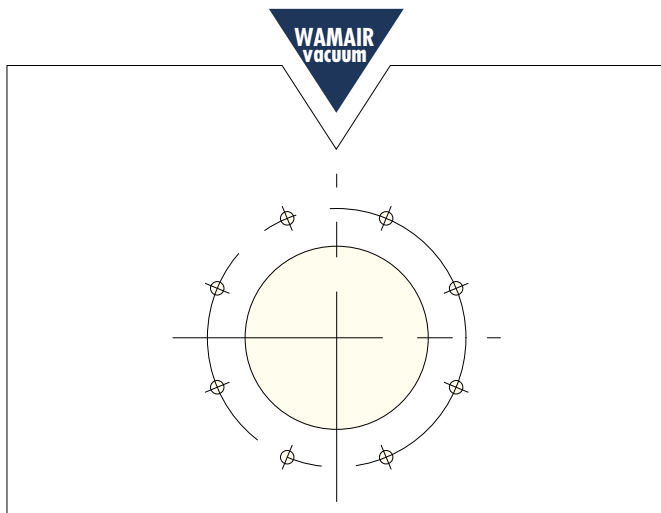

Air outlet flange PN 10
 Luftauslaßflansch PN 10
 Sortie d'air avec bride PN 10
 Flangia uscita aria PN 10



WAM S.p.A.
Via Cavour, 338
I - 41030 Ponte Motta
Cavezzo (MO) - ITALY
Tel: +39 0535 61 81 11
Fax: +39 0535 61 82 26
info@wamgroup.com
www.wamgroup.com

Further Products - Weitere Produkte - Autre production - Altra produzione

